

R-079

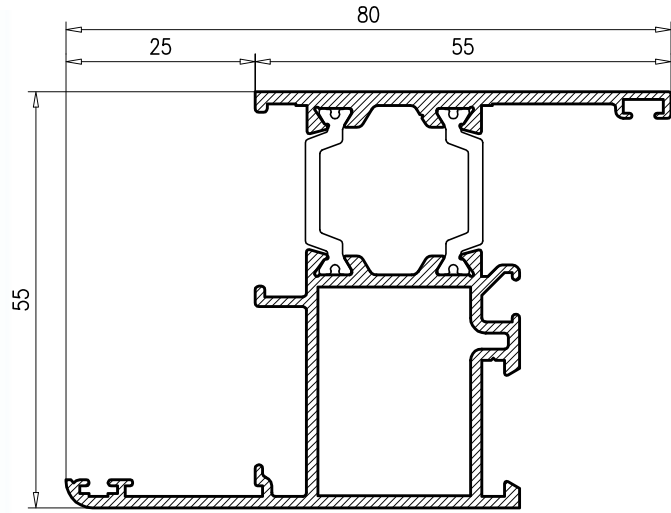

R-047

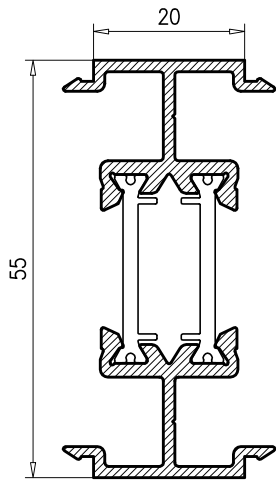

R-054

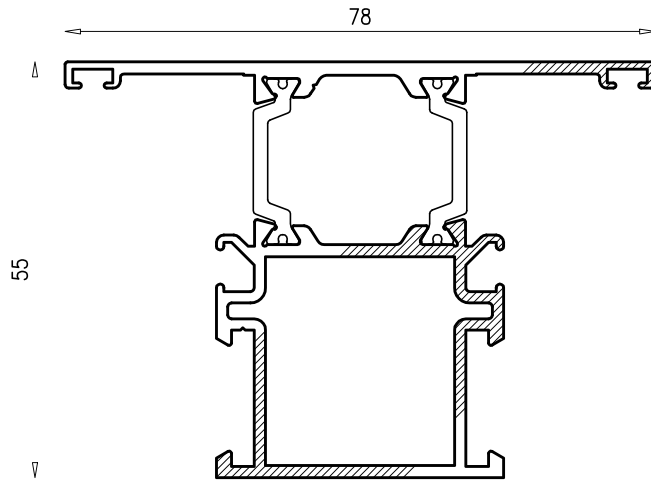

R-058

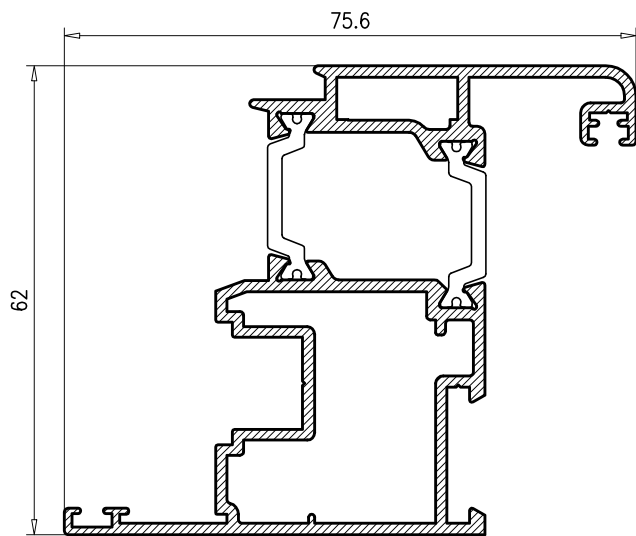

R-056

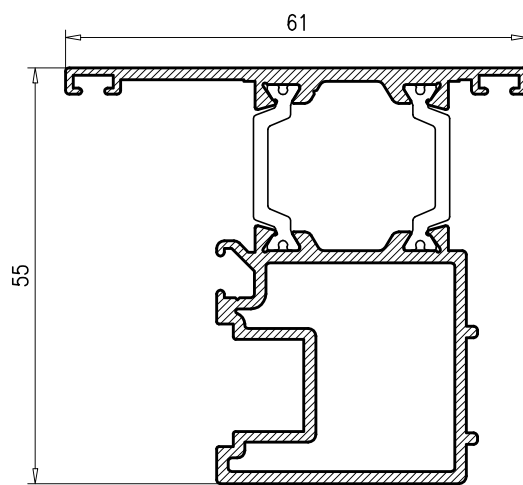



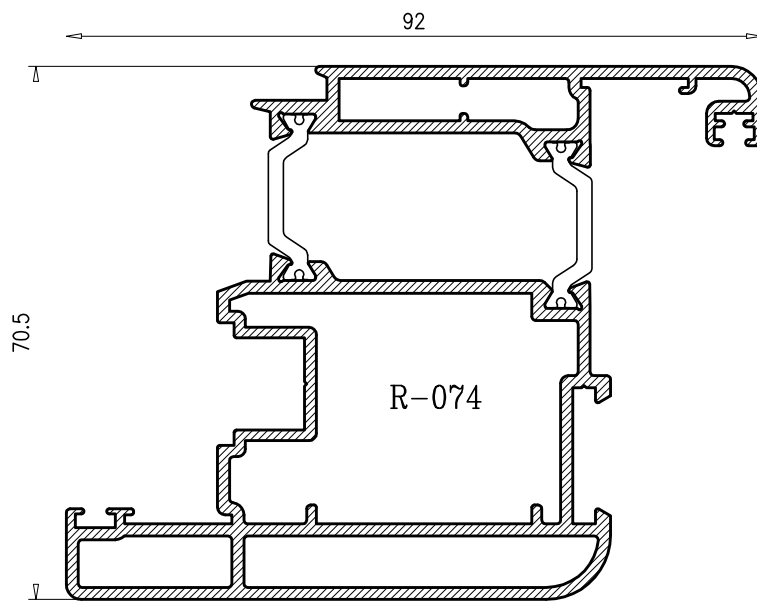
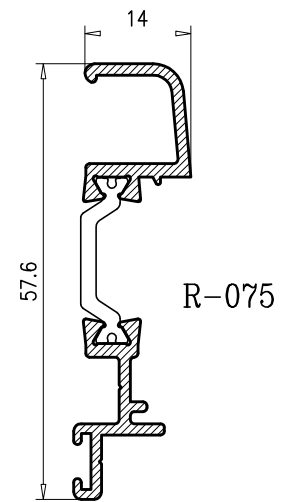
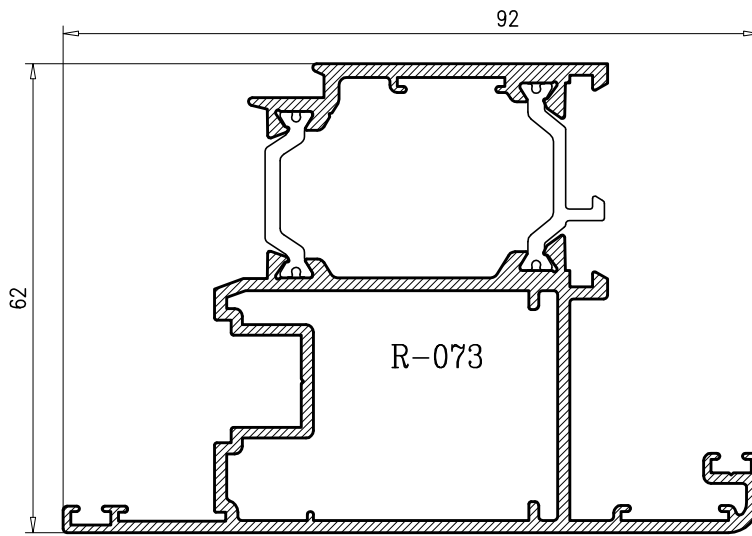
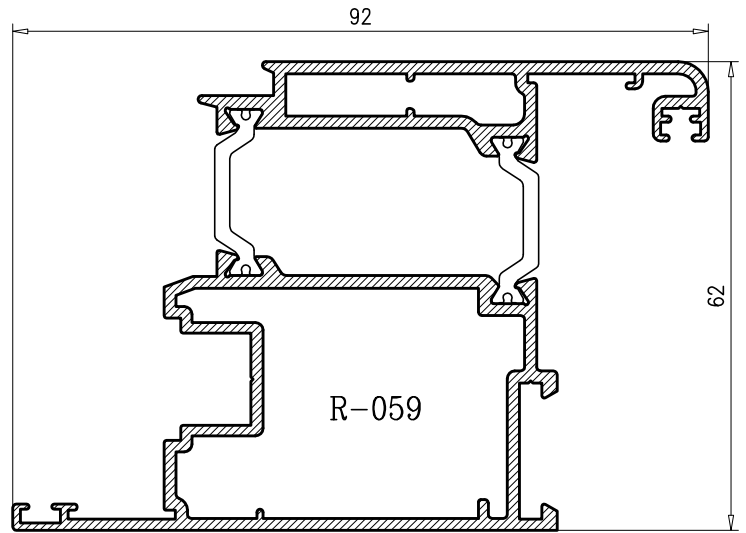
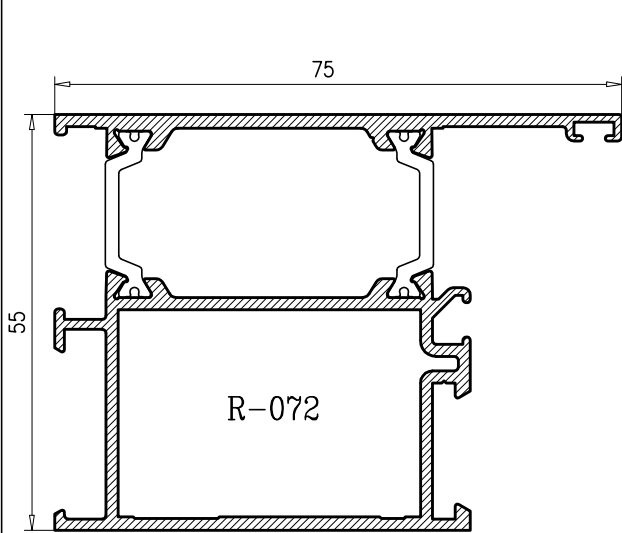



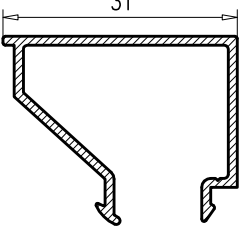
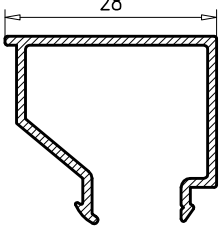
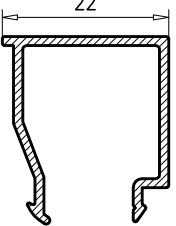
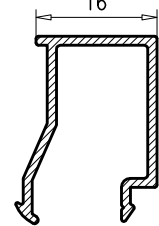
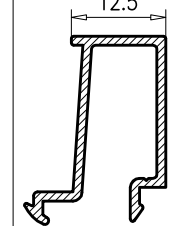
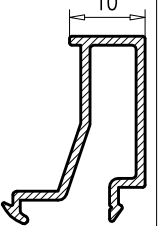
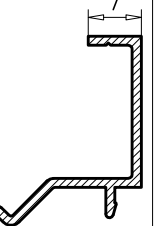
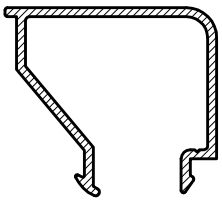
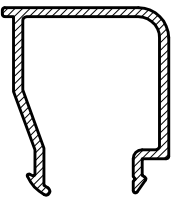
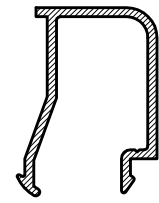
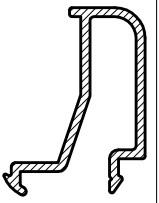
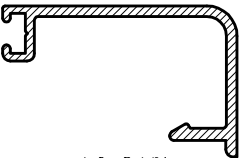
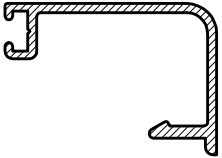
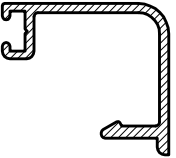
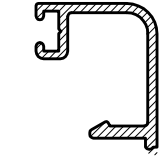
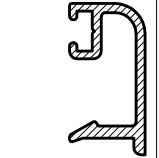
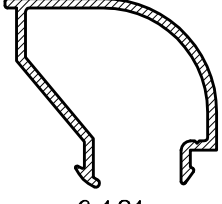
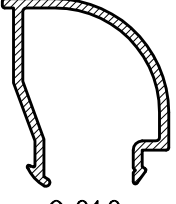
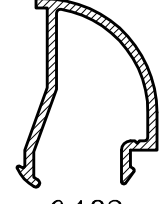
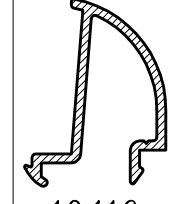
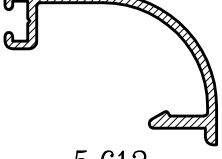
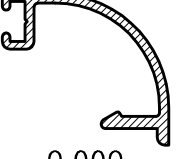
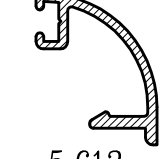
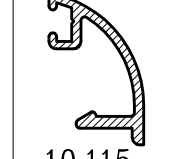
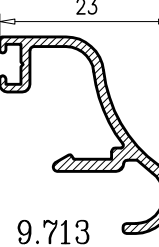
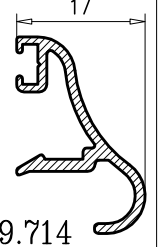
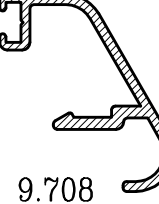
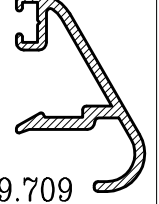



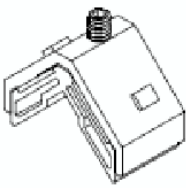
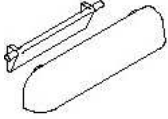
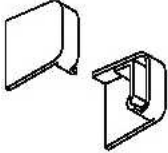

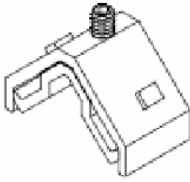
R-057

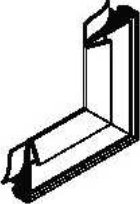
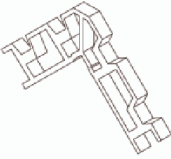



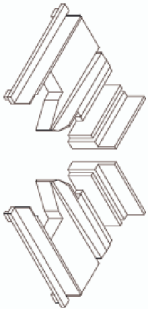

Hoja Apertura Osciloparalela







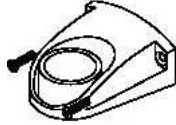
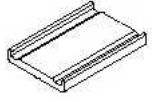

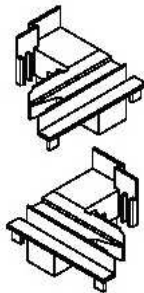

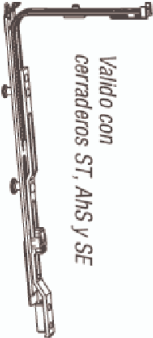

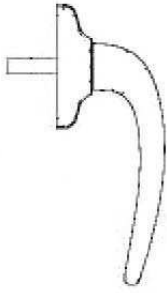

40mm	Cámara:	8.5	14.5	20.5	24	26.5	29.5
45mm	Cámara: 10.5	13.5	19.5	25.5	29	31.5	34.5
55mm	Cámara: 20.5	23.5	29.5	35.5	39	41.5	44.5
							
							
							
							
							
							
							

# SERIE 16 RPT



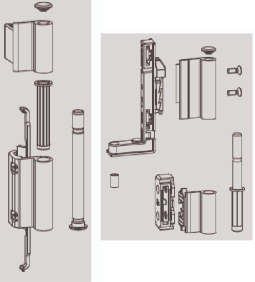

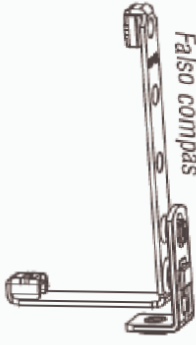

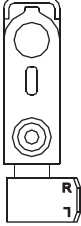



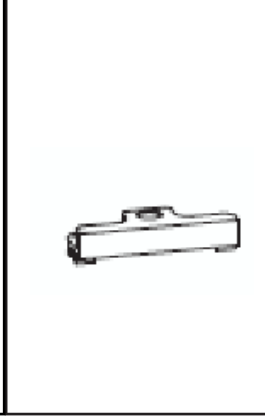
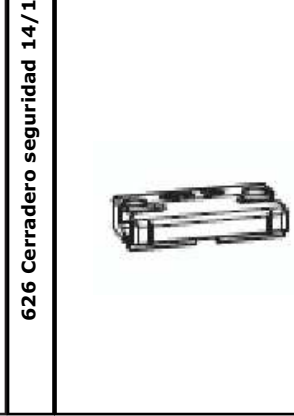

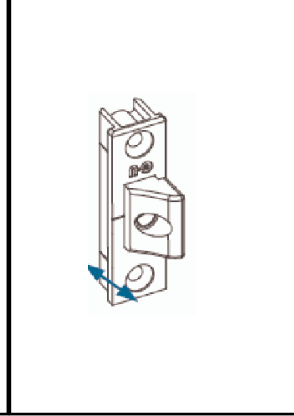
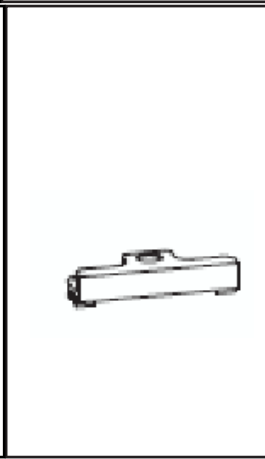
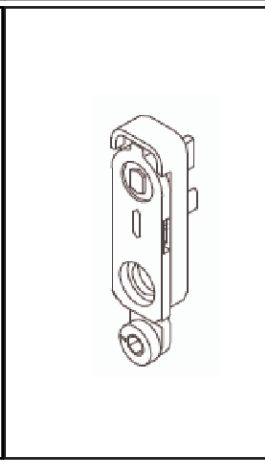
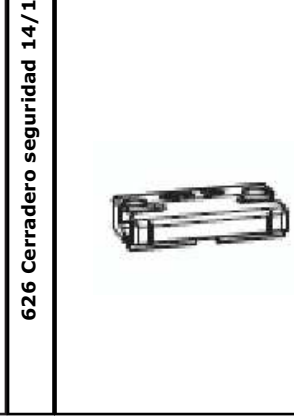

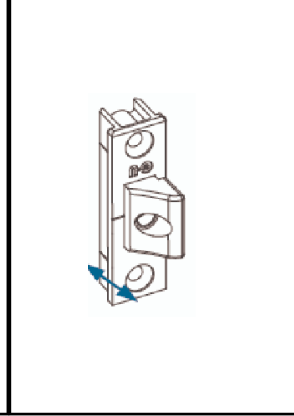
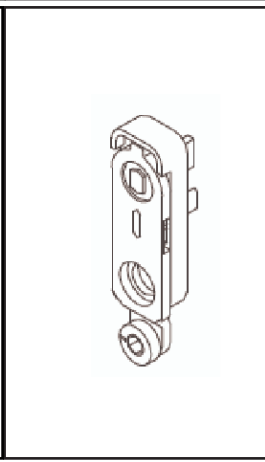
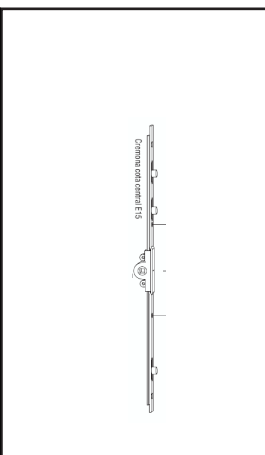
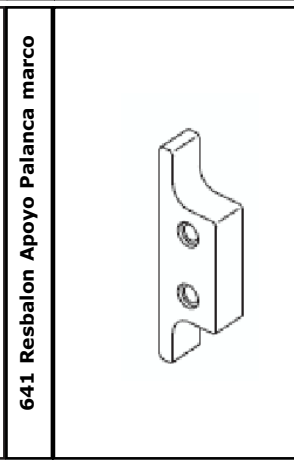

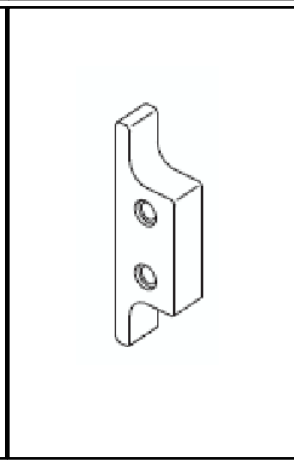
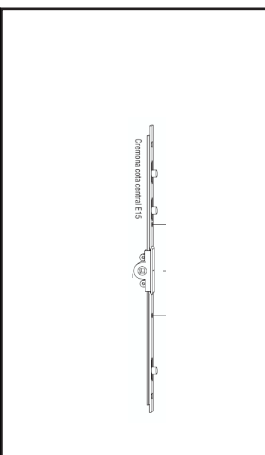
472 Escuadra marco		735 Tapa Desagüe		465 Tapas Laterales para 9619		773 Junta para marco y hoja	
473 Escuadra hoja		798 Escuadra Alineamiento Interior		262 Tornillo para Vierendeaguas 9619		232 Ángulo Junta Central	
471 escuadra alineamiento		758 Escuadra de Alinear Inox Fina		746 Grapa Junquillo Grande		774 Junta Central	
469 Tapas inversor R-057		107 Escuadra de Alinear Inox Gruesa		779 Grapa Junquillo Pequeña		448 Junta exterior marco	

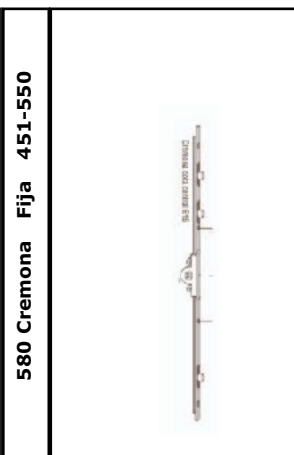

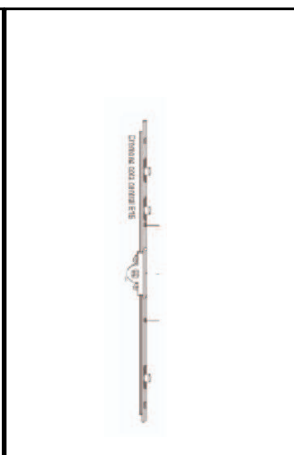

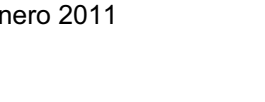



# SERIE 16 RPT

784 Escudo Junquillos Curvos		83 Unión Divisores 55 mm		219 Soporte Tubo 50mm Tirador		906 Grapa para Junquillo 12207	
705 Grapa Lama Rejilla		466 Tope Desagüe Hojas		487 Tapa Inversor de 10898			

<p><b>325 Tirante 215 dk-k 180° horizontal</b></p>  <p><i>Valido con cerradores ST, Ahs y SE</i></p>	<p><b>330 Brazo Compas 280-500</b></p> 	<p><b>188 Pletina Compas 280-500</b></p> 	<p><b>710 Maneta Ventana Multipunto</b></p> 
<p><b>326 Tirante Standar 1101-1350/740</b></p> 	<p><b>331 Brazo Compas 501-750</b></p> 	<p><b>189 Pletina Compas 501-750</b></p> 	<p><b>182 Manilla Atlanta</b></p> 
<p><b>327 Tirante Standar 1851-2100/1450</b></p> 	<p><b>332 Brazo Compas 751-1200</b></p> 	<p><b>191 Pletina Compas 751-950</b></p> 	<p><b>183 Conjunto Bisagras uni-jet 13x20</b></p> 
<p><b>322 Trasmision angulo escuadra oscilo</b></p>  <p><i>Transmision de ángulo</i></p>	<p><b>328 Falso Compas uni-jet</b></p>  <p><i>Falso compás</i></p>	<p><b>192 Pletina Compas 951-1200</b></p> 	<p><b>195 Anti-Falsa Maniobra s/elev.</b></p> 

# Serie 16 RPT

<p>578 Cremona Fija 350-450</p> 	<p>187 Antifalsa-Maniobra con ele.</p> 	<p>615 Terminal 90° bulon</p> 	<p>203 Trasmision Angulo SLK</p> 	<p>616 Terminal 180° sin bulon</p> 
<p>625 Cewrradero Standar 14/18</p> 	<p>187 Antifalsa-Maniobra con ele.</p> 	<p>619 Prolongador 500 con bulon</p> 	<p>617 Bisagra Oculta Hoja</p> 	<p>618 Bisagra Oculta Marco</p> 
<p>580 Cremona Fija 451-550</p> 	<p>641 Resbalon Apoyo Palanca marco</p> 	<p>642 Resbalon Apoyo antifalsa ma.</p> 	<p>620 Prolongador Cremona s/bulon 250</p> 	<p>616 Terminal 180° sin bulon</p> 
<p>581 Cremona Fija 551-720</p> 	<p>618 Bisagra Oculta Marco</p> 	<p>617 Bisagra Oculta Hoja</p> 	<p>617 Bisagra Oculta Hoja</p> 	<p>617 Bisagra Oculta Hoja</p> 
<p>582 Cremona Fija 721-850</p> 	<p>617 Bisagra Oculta Hoja</p> 	<p>617 Bisagra Oculta Hoja</p> 	<p>617 Bisagra Oculta Hoja</p> 	<p>617 Bisagra Oculta Hoja</p> 

583 Cremona Fija 851-1100		592 Palanca Rebajo 470-720		596 Palanca Rebajo 1351-1600		
584 Cremona Fija 1101-1350		593 Cremona Rebajo 721-850		597 Palanca Rebajo 1851-2100		
586 Cremona Fija 1351-1600		594 Palanca Rebajo 851-1100				
587 Cremona Fija 1851-2100		595 Palanca Ra Rebajo 1101-1350	