

8431

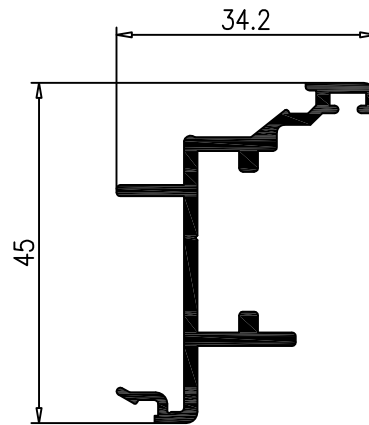

8484

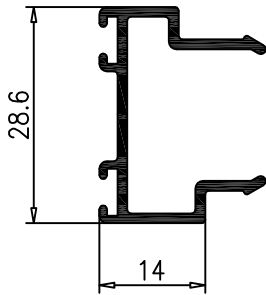

* 8570

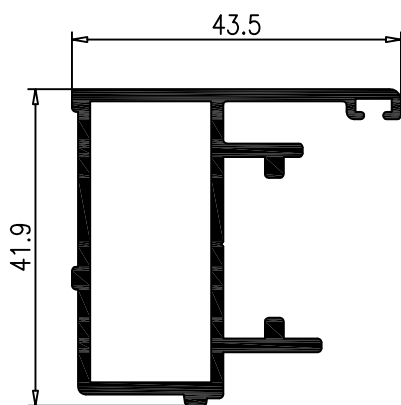

8485

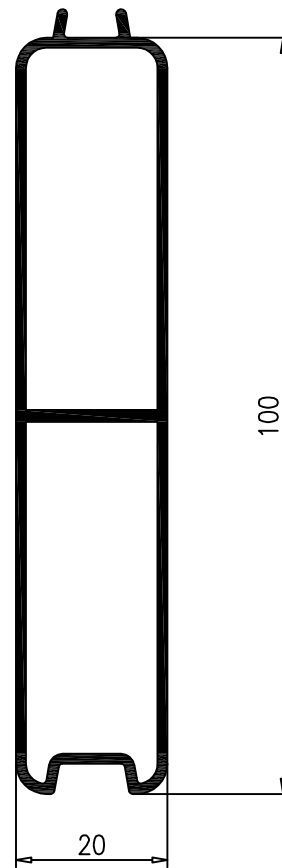

8564

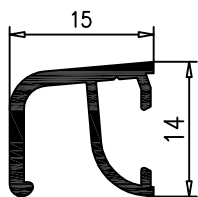

9619

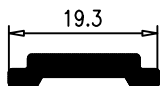

3686

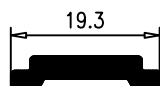

722

POLIAMIDA



11800
savio

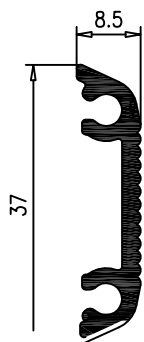
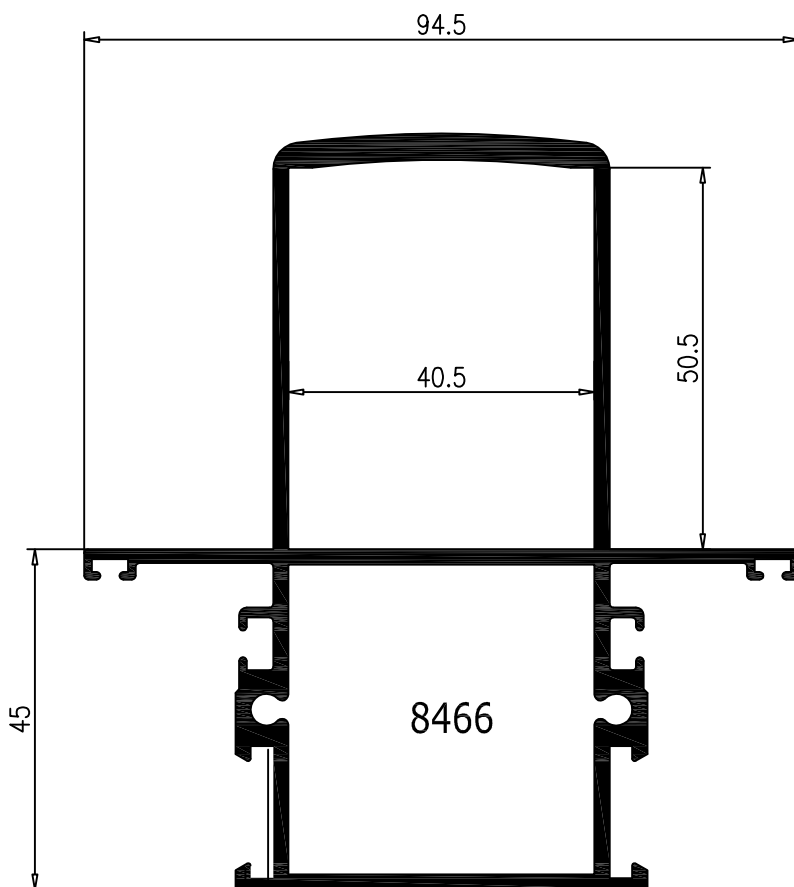

* 8487

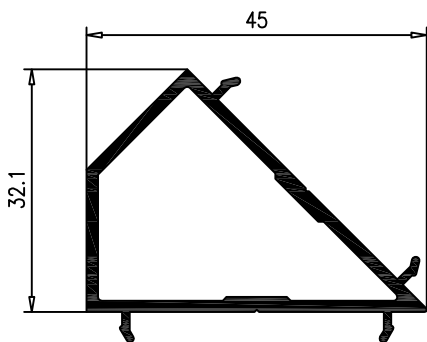
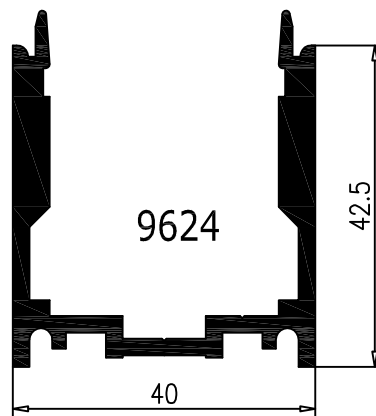
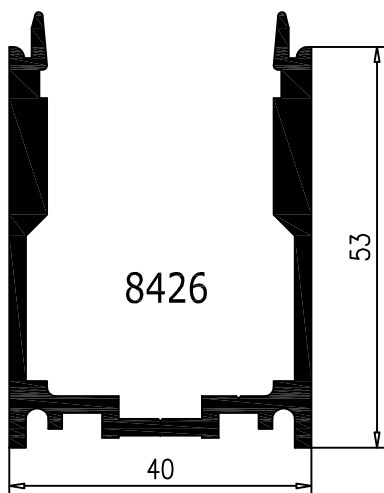
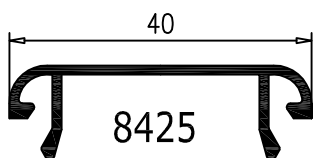

* 7057

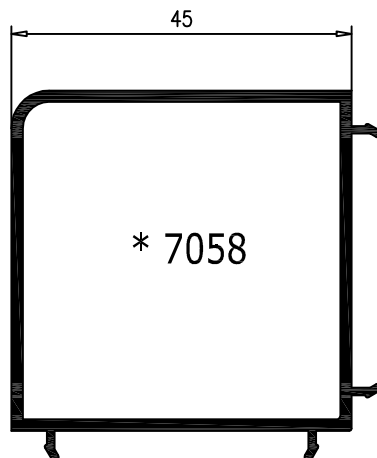

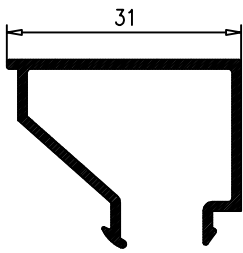

3358
Hueco-10

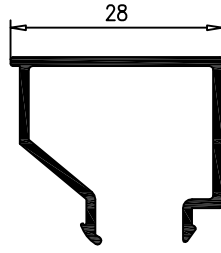

9025
Hueco-13

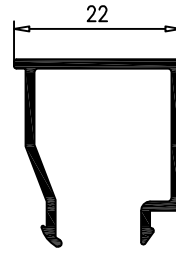

3360
Hueco-19

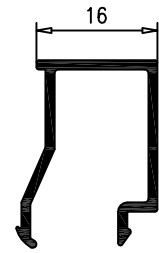

9026
Hueco-25

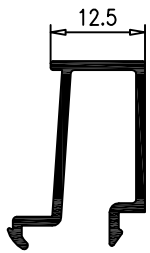

10252
Hueco-29

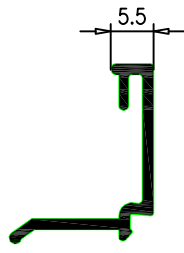

12207
Hueco-35.5

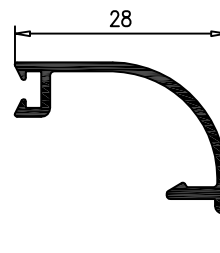

5612
Hueco-13

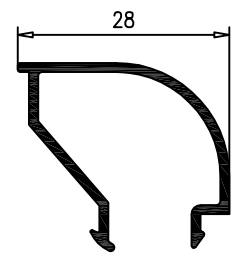

6181
Hueco-13

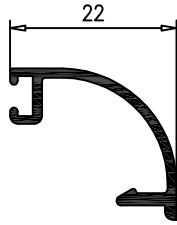

9009
Hueco-19

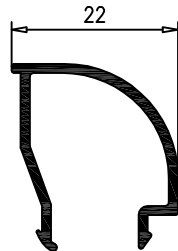

9010
Hueco-19



5613
Hueco-25

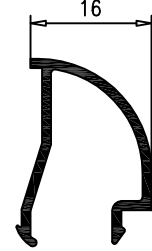



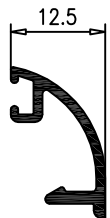





6182
Hueco-25

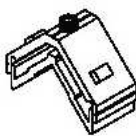

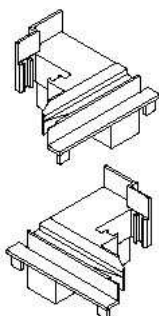
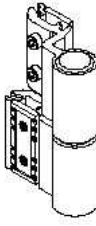
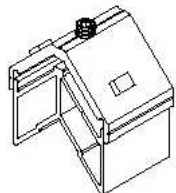

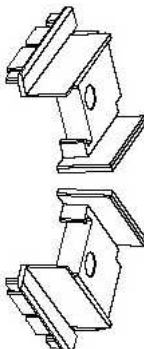
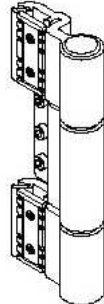
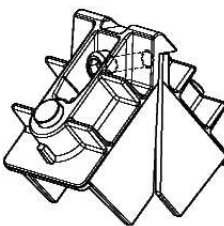
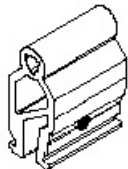
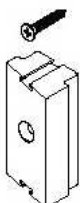

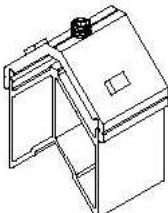
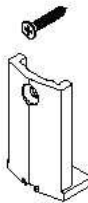

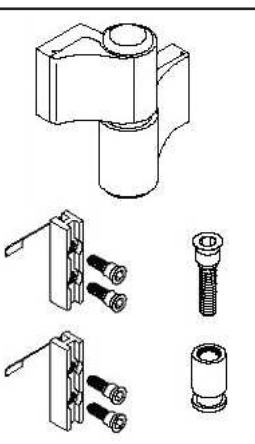
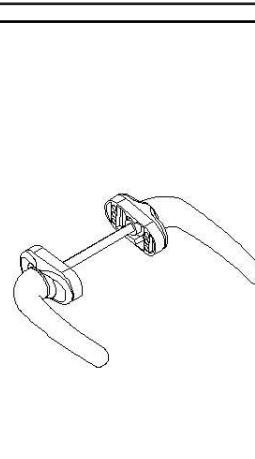
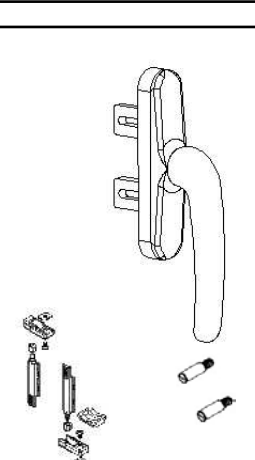
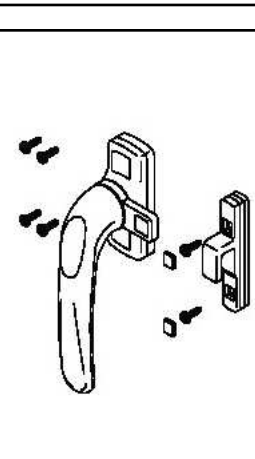
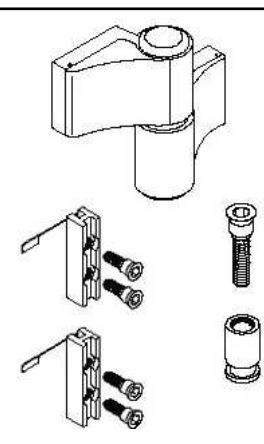
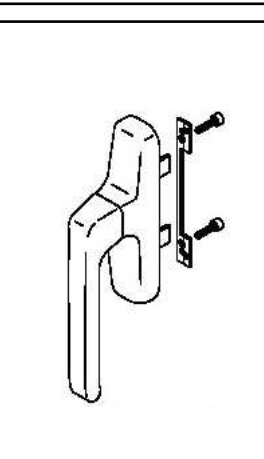
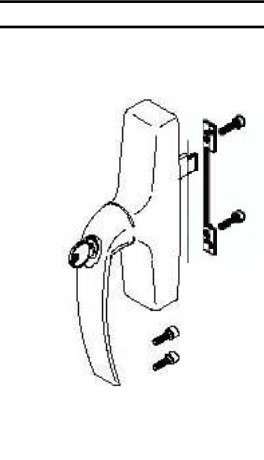
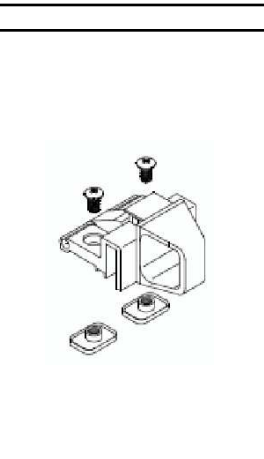
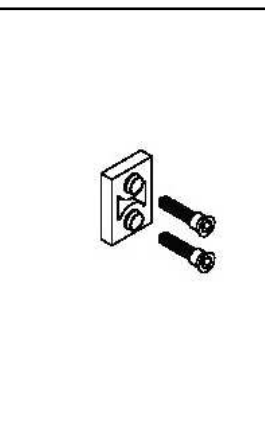
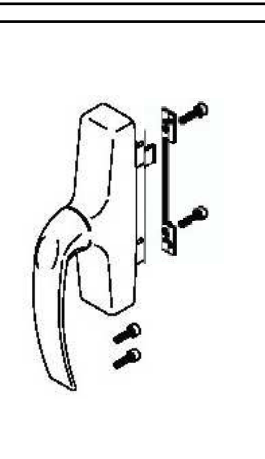
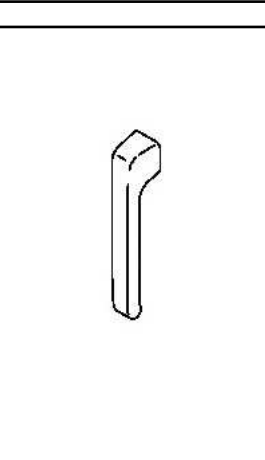
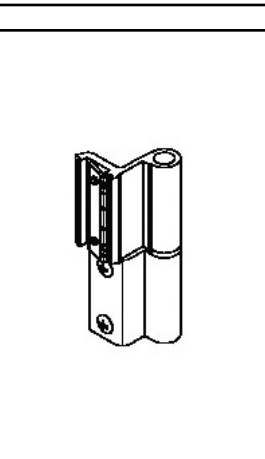
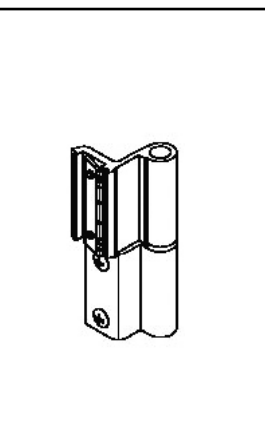
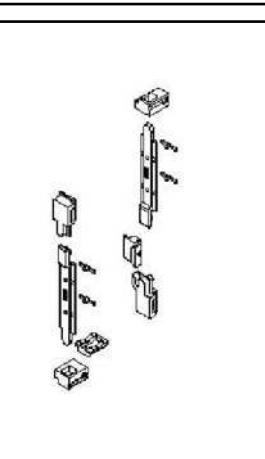
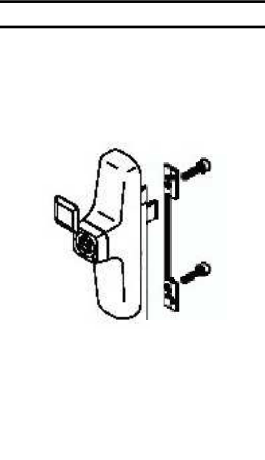
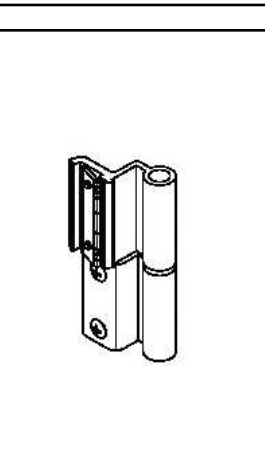

10115
Hueco-29

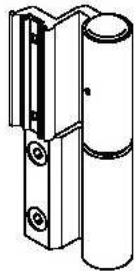
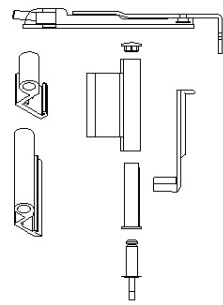

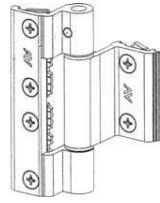
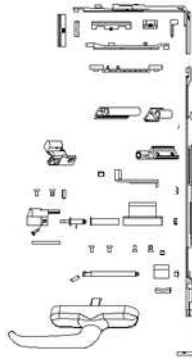
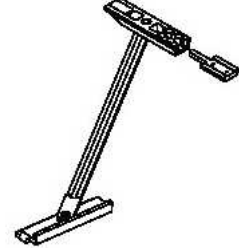



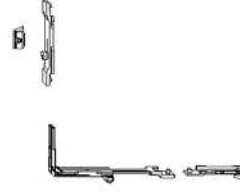
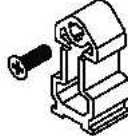

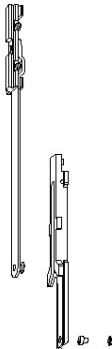
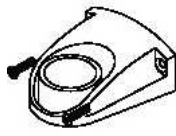

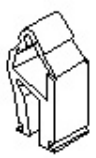
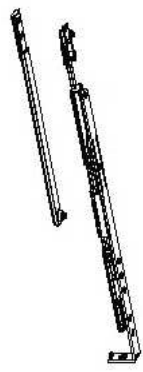

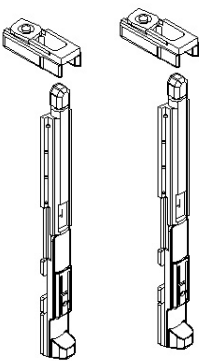



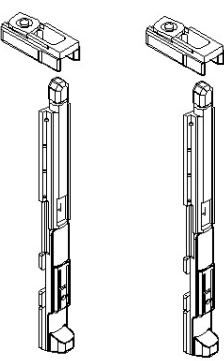
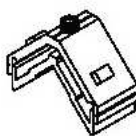

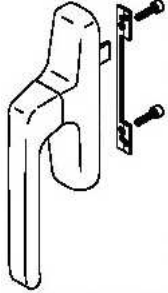
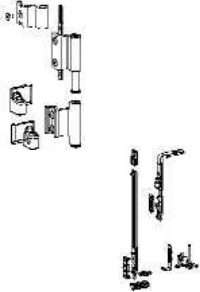
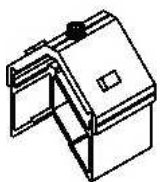



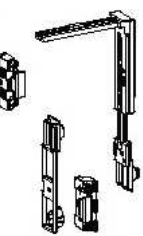

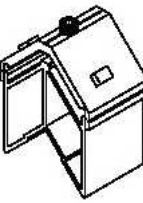
10116
Hueco-29

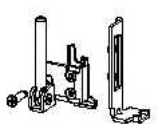

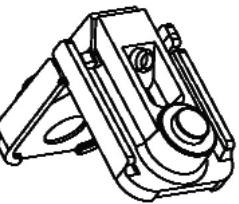

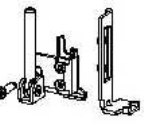

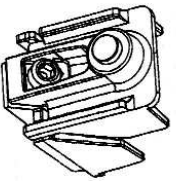
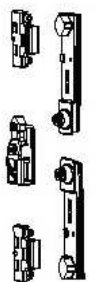

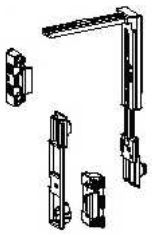
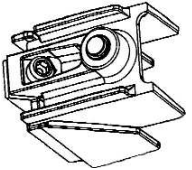

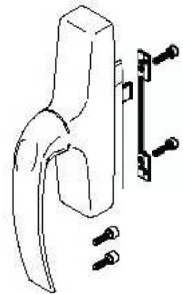
748 Escuadra 40 x 25		675 Junta Estanqueidad Hoja		725 Tapa Inversor 7197		601 Bisagra Rápida 2 Alas	
268 Escuadra 40 x 45		676 Junta Estanqueidad Marco		672 Tapa Inversor 8483		602 Busagra Rápida 3 Alas	
699 Escuadra Hoja 45 x 45		697 Unión 45 x 45		673 Falca Marco/Hoja		666 Cerradero a Marco	
671 Cerradero a Suelo		694 Escuadra 45 x 45		674 Falca Inversor/Hoja		899 Escuadra Graduable 40 x 18	

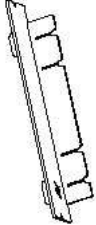



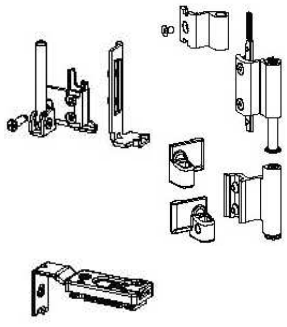
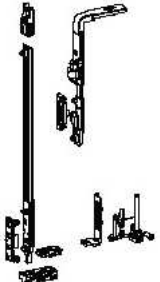
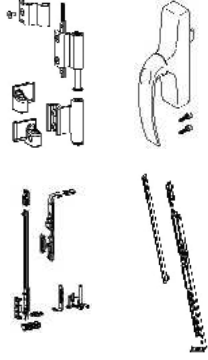

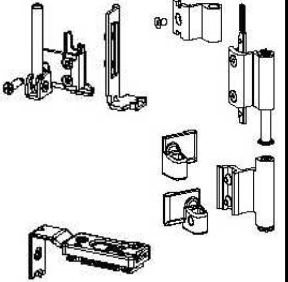
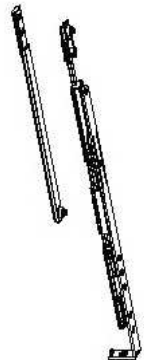
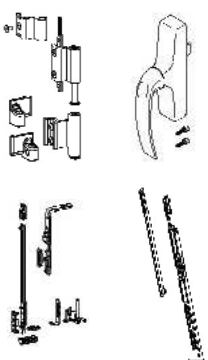

<p>35 Cierre a presión</p>		<p>362 Juego Manilla Recuperable</p>		<p>60003 KIT Cremona Exterior</p>		<p>707 Bisagra Reversible</p>	
<p>604 Bisagra Superpuesta 62.5</p>		<p>358 Cremona Abisagrada de Serysys</p>		<p>974 Cremona 1 Pala con Llave de Savio</p>		<p>711 Bisagra Hoja Con inversor 2ªh</p>	
<p>605 Bisagra Superpuesta 84</p>		<p>998 Cremona Abisagrada de Savio</p>		<p>977 Mailla Cremona de Savio</p>		<p>464 Suplemento para 604-605 Serie 22</p>	
<p>870 Bisagra savio</p>		<p>997 conjunto Cremona Microventilación</p>		<p>978 Cremona sin Manilla 1 Pala de Savio</p>		<p>870 Bisagra savio</p>	



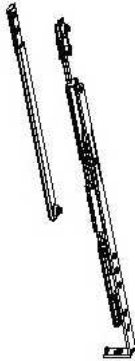
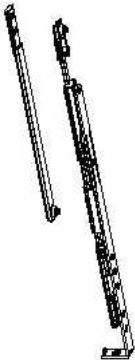

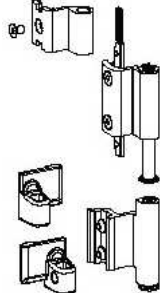
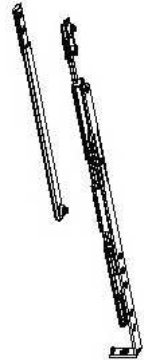
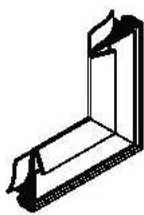

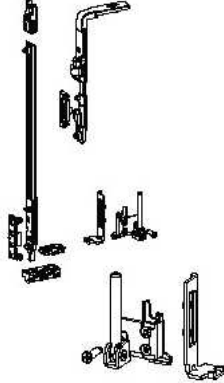
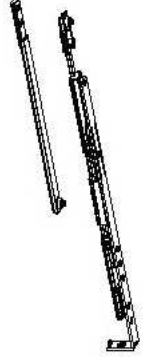
<p>499 Bisagra Reforzada</p>		<p>393 Bisagra Osc.regul. 2ª H Serysys</p>		<p>784 Escudo Junquillos Curvos</p>		<p>512 Compás Proyectante de Serysys 26</p>	
<p>738 Bisagra tres nudos de savio</p>		<p>151 conjunto Oscilo 350-410 Serysys</p>		<p>297 Compás Abatible</p>		<p>513 Compás Proyectante de Serysys 47</p>	
<p>466 Tope Desagüe Hojas</p>		<p>152 conjunto Oscilo 410-600 Serysys</p>		<p>357 conjunto Osc. Horiz/Verti Serysys</p>		<p>83 Unión Divisores 55 mm</p>	
		<p>153 conjunto Oscilo 600-1200 Serysys</p>		<p>392 Segundo Compás Osc. de Serysys</p>		<p>219 Soporte Tubo 50mm Tirador</p>	

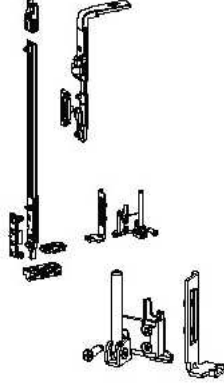
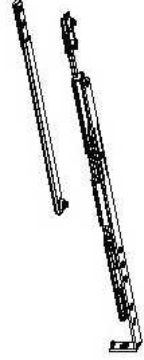
<p>698 Unión para T 40 x 20</p>		<p>391 Compás Oscilo 300-410 Serysys</p>		<p>976 Pasadores de Savio</p>		<p>510 Pasadores de Ventana de Serysys</p>	
<p>751 Unión para T 40 x 40</p>		<p>353 Compás Oscilo 410-600 Serysys</p>		<p>996 Pasadores de Leva de Savio</p>		<p>511 Pasadores de Puerta de Serysys</p>	
<p>748 Escuadra 40 x 20</p>		<p>354 Compás Oscilo 600-1200 Serysys</p>		<p>352 Cremona Oscilo de Serysys</p>		<p>355 conjunto bisagra Oscilo Serysys</p>	
<p>749 Escuadra 40 x 40</p>		<p>798 Escuadra Alineamiento Interior</p>					

<p>966 conjunto Superior 2h. Dcha. Savio</p>		<p>962 conjunto Vertical Izqui. Savio</p>		<p>758 Escuadra de Alinear Inox Fina</p>		<p>754 Escuadra Hoja 7945</p>	
<p>967 conjunto Superior 2h. Izq. Savio</p>		<p>964 conjunto Inferior 2h. Dcha. Savio</p>		<p>107 Escuadra de Alinear Inox Gruesa</p>		<p>755 Escuadra Marco- Hoja 40 x 20</p>	
<p>968 Cerradero Hoja Pasiva de Savio</p>		<p>965 conjunto Inferior 2h. Izq. Savio</p>		<p>960 Cerradero Intermedio Savio</p>		<p>756 Escuadra Marco-Hoja 40 x 40</p>	
<p>972 conjunto cerradero Derecha Savio</p>		<p>975 Cerradero Regulable de Savio</p>		<p>961 conjunto Vertical Dere. Savio</p>		<p>757 Escuadra Marco-Hoja 40 x 45</p>	

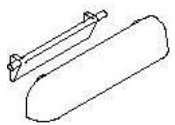
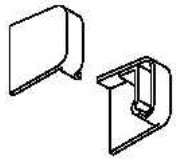
<p>951 Cremona de Oscilo de Sabio</p>		<p>61802 KIT Oscilo Dere. 510-794 Savio</p>		<p>969 Plantilla Kit Bisagra de Savio</p>		<p>973 conjunto cerradero Izquierda Savio</p>	
<p>952 conjunto Base Vertical Dere. Savio</p>		<p>61803 KIT Oscilo Izqui. 510-794 Savio</p>		<p>970 Plantilla Kit Maro de Savio</p>		<p>61806 KIT Bisagra 2ªH. Dcha. Savio</p>	
<p>953 conjunto Base Vertical Izqui. Savio</p>		<p>61804 KIT Oscilo Der. 795-1700 Savio</p>		<p>61800 Kit Oscilo Dere. 360-509 Savio</p>		<p>61807 KIT Bisagra 2ªH. Izq. Savio</p>	
<p>954 Compas Derecho 360-509 de Savio</p>		<p>61805 KIT Oscilo Izqui. 795-1700 Savio</p>		<p>61801 KIT Oscilo Izqui. 360-509 Savio</p>		<p>11800 Pletina Oscilobatiante de Savio</p>	

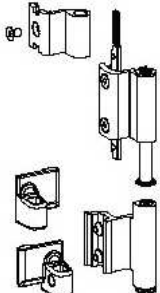
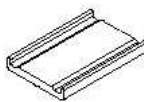
774 Junta Central		571 2º Compás Oscilo Derecho de Savio		959 Compás Izquierdo 795-1700 Savio		955 Compás Izquierdo 360-509 de Savio	
347 Ruleta Junta Central		572 2º Compás Oscilo Izquierdo Savio		963 juego Bisagra Oscilo 110 Kg Savio		956 Compás Derecho 510-794 de Savio	
232 Ángulo Junta Central		123 Refuerzo Bisagra 140Kg Izq.		807 conjunto Horizontal Dere. Savio		957 Compás Izquierdo 510-794 de Savio	
773 Goma para Marco y Hoja		124 Refuerzo Bisagra 140Kg Dcha.		811 conjunto Horizontal Izqui. Savio		958 Compás Derecho 795-1700 de Savio	

262 Tornillo para Vierendeaguas 9619		779 Grapa Junquillo Pequeña		735 Tapa Desagüe	
465 Tapas Laterales para 9619		366 Cerradero Eléctrico		705 Grapa Lama Rejilla	
139 Bisagras oscilo 2h.sin reg. savio		906 Grapa para Junquillo 12207		746 Grapa Junquillo Grande	

60283	→ Cerradura Golpe y Llave Seguridad
	PVP EURO
<p>Contenido: 291 Cerradura 1unid. 272 Cilindro 1 unid. 627 Cerradero 1 unid.</p>	

60284	Cerradura Rodillo y Llave Seguridad
	PVP EURO
<p>Contenido: 292 Cerradura 1unid. 272 Cilindro 1 unid. 628 Cerradero 1 unid.</p>	

60285	Cerradura Solo Llave Seguridad
	PVP EURO
<p>Contenido: 293 Cerradura 1unid. 272 Cilindro 1 unid. 629 Cerradero 1 unid.</p>	

60286	Cerradura Golpe y Llave 3 Ptos Seguridad
	PVP EURO
<p>Contenido: 294 Cerradura 1unid. 272 Cilindro 1 unid. 627 Cerradero 1 unid. 629 Cerradero 2 unid.</p>	

60287	Cerradura Rodillo y Llave 3 P. Seguridad
	PVP EURO
<p>Contenido: 295 Cerradura 1unid. 272 Cilindro 1 unid. 628 Cerradero 1 unid. 629 Cerradero 2 unid.</p>	

62801	Cerradura Multitop Llave 3 Pto. Seguridad
	PVP EURO
<p>Contenido: 537 Cerradura 1 unid. 272 Cilindro 1 unid. 306 Cerradero 1 unid. 307 Cerradero 2 unid.</p>	